

# Data Sheet



Article number: 201362NI6040ABL

Description: E+G Hinge for welding GN 1362-NI-60-40-A-BL  
Stainless steel AISI 304

## Measures

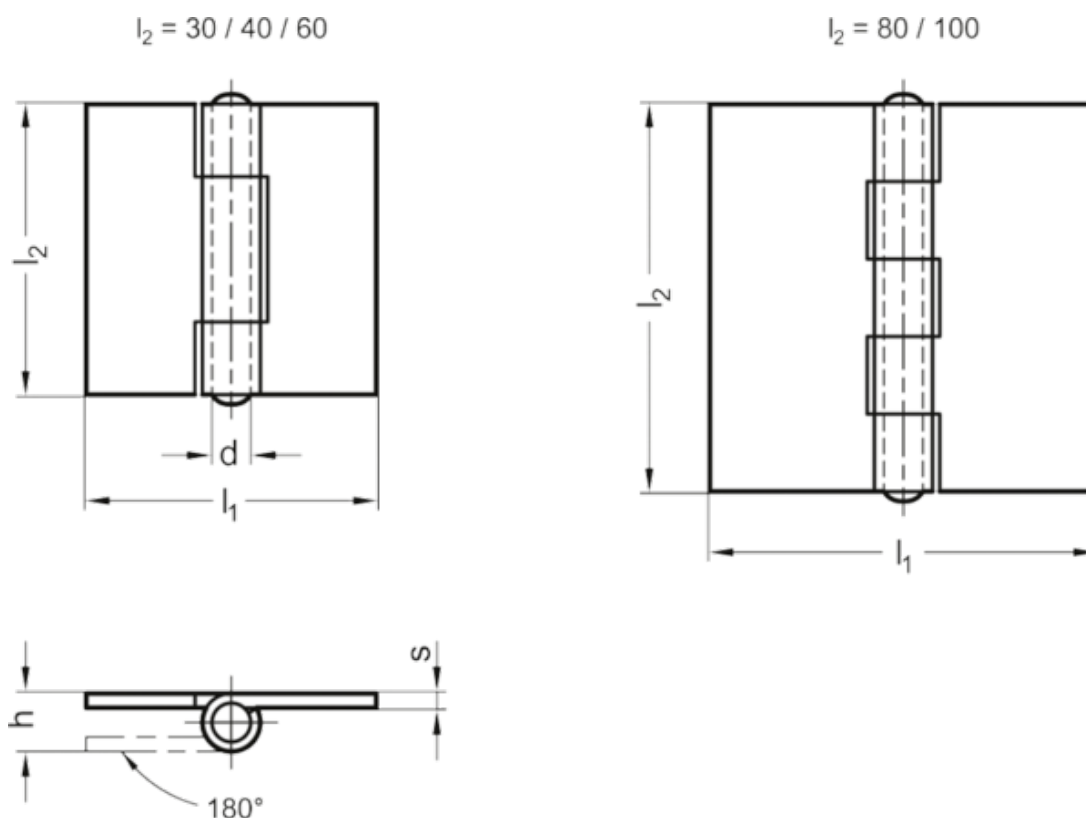

d	= 6
h	= 12
l1	= 60
l2	= 40
s	= 3
Weight in (g)	= 80